

# ASTERIX/ASTERIX HD

## BROCHURE

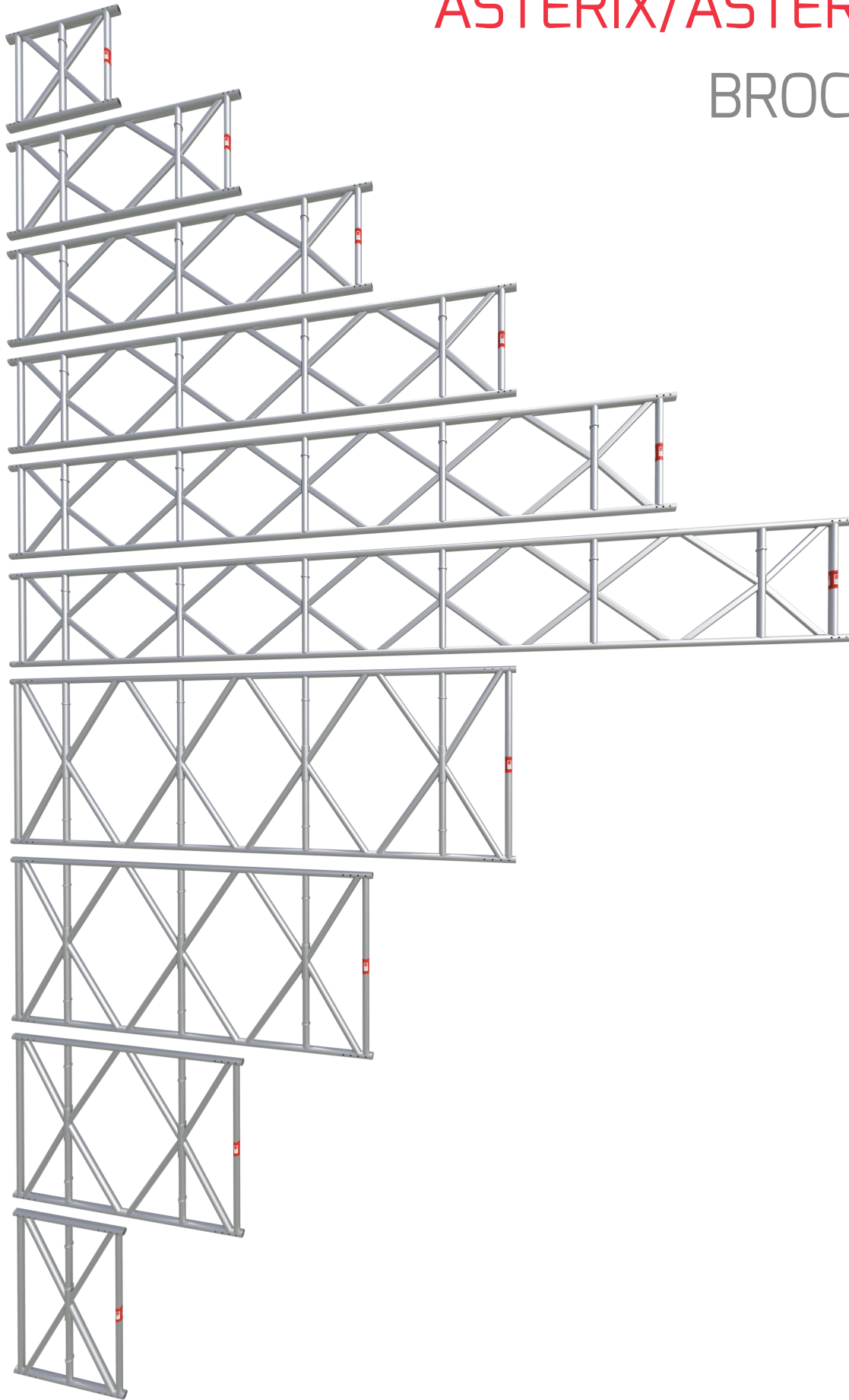



# ASTERIX/ASTERIX HD

## ● Introducing DESSA

DESSA (Design, Engineer, Supply, Safety and Access) was founded in 2010 by a team of leading UK scaffolding experts. DESSA has grown to be a major supplier of temporary roofing and cladding systems, aluminium lattice girders, scaffold accessories, site stairways and safety products. DESSA became part of the Altrad Group of Companies in 2015 and continues to develop exciting, innovative and cost effective solutions. Offering design support services, DESSA has become the one-stop solution provider to contractors at all levels.

## ● DESSA ASTERIX Aluminium Beam Range

The ASTERIX beam range are manufactured to the stringent requirements of EN1090 ensuring every beam can be traced individually. These beams offer unrivalled strength capability and are compatible with tube and fittings and/or modular system scaffolds. Beams are joined using steel spigots and quick release pins. 18° and 36° ridge beams as well as bolt-free lacing and bracing kits are available from stock.



## ● SAME JOB - LESS BEAMS!

GENERAL  
450mm BEAMS

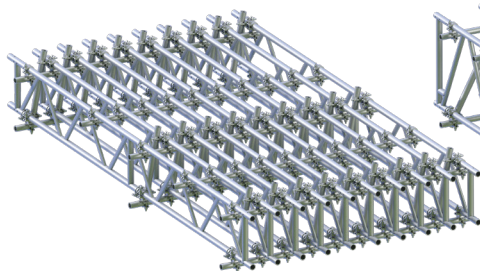

10NO. RUNS\*

GENERAL  
750mm BEAMS

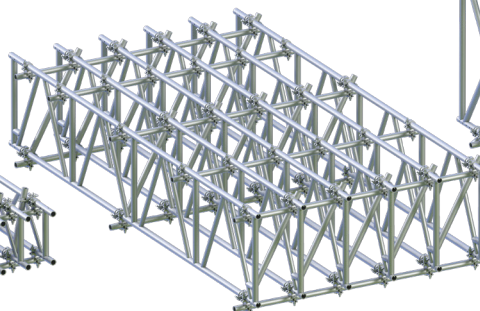

6NO. RUNS\*

ASTERIX HD BEAMS

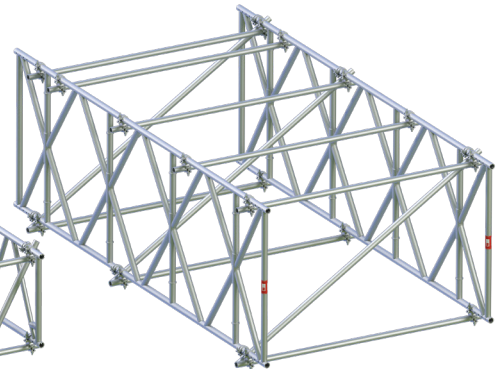

2NO. RUNS\*

\*ALL DESIGNS TO BE CARRIED OUT  
BY A COMPETENT DESIGN ENGINEER.

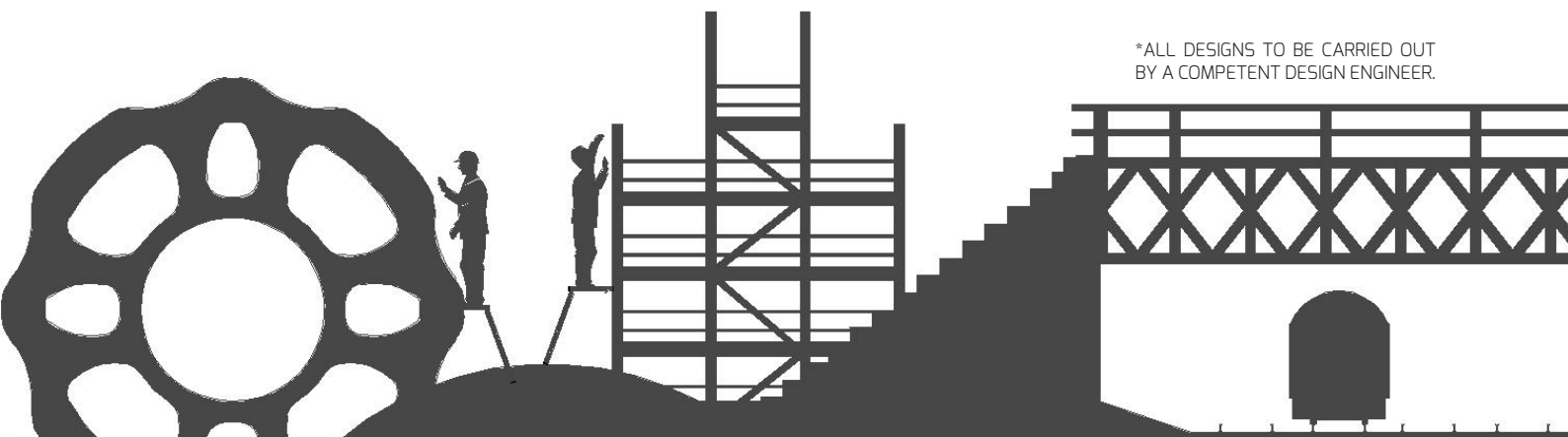

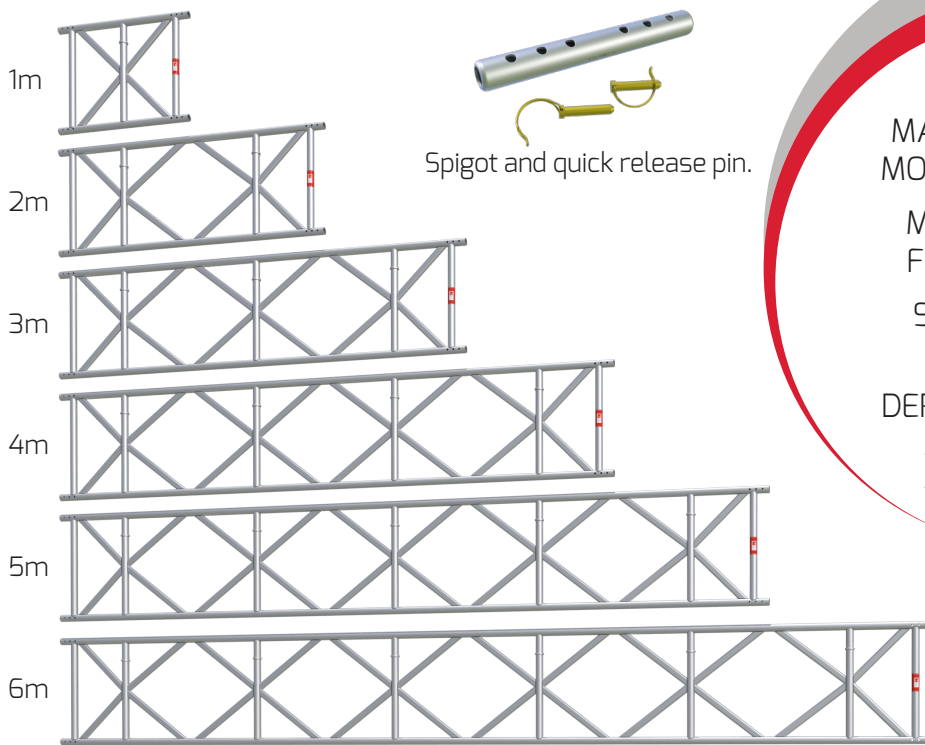

Spigot and quick release pin.

**ASTERIX**

MAXIMUM BENDING MOMENT\*\* 41.31kNm

MAXIMUM SHEAR FORCE\*\* 23.73kN

STOCK LENGTHS 1,2,3,4,5,6m

DEPTH = 702mm C/C

\*\* FULL DATA SHEET AVAILABLE ON REQUEST.

Bolt-free lacing and bracing kit available.

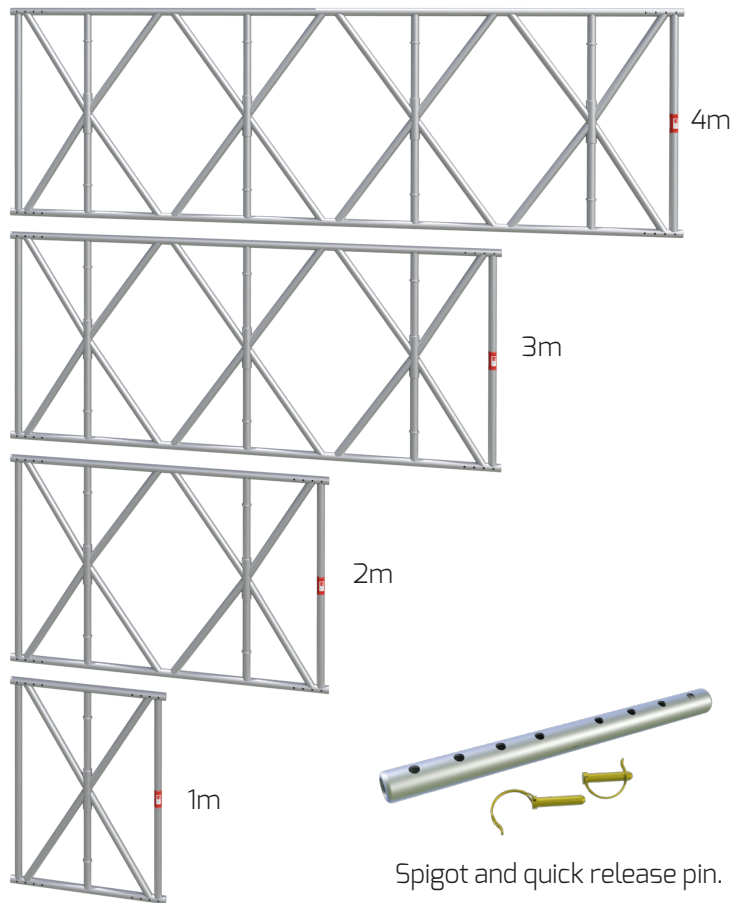

Spigot and quick release pin.

Bolt-free lacing and bracing kit available.

**ASTERIX HD**

MAXIMUM BENDING MOMENT\*\* 102.20kNm

MAXIMUM SHEAR FORCE\*\* 32.60kN

STOCK LENGTHS 0.55,1,2,3,4m

DEPTH =1280mm C/C

\*\* FULL DATA SHEET AVAILABLE ON REQUEST.

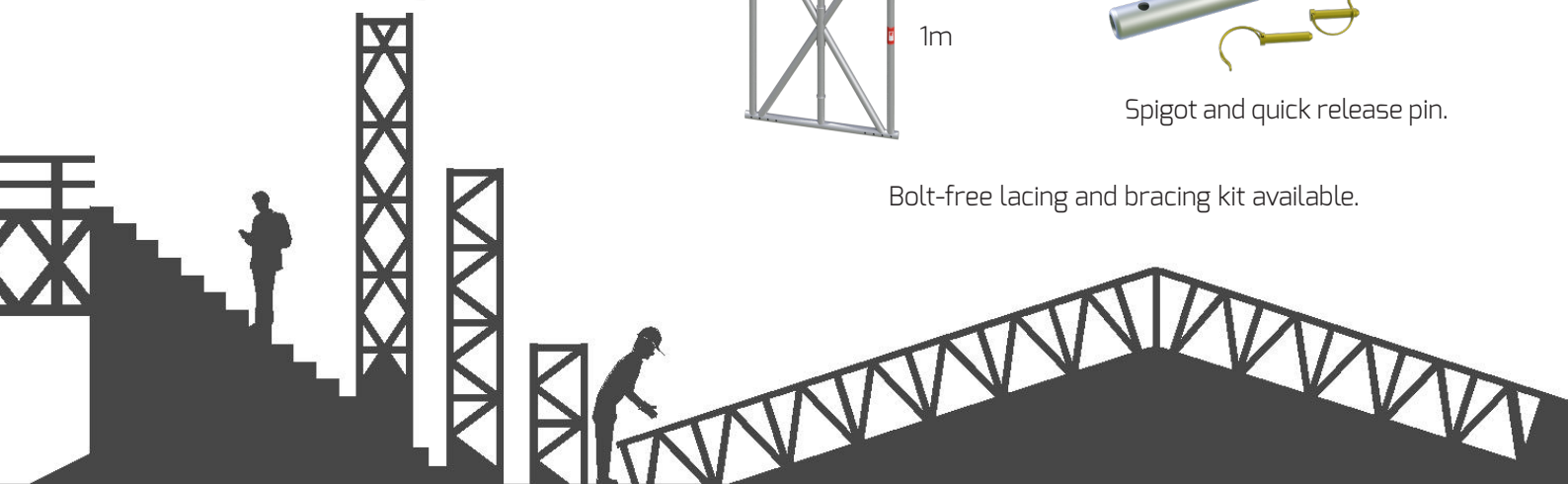



DESSA  
SCAFFOLD  
PRODUCTS  
TECHNICAL  
SERVICES

DESSA LIMITED  
Unit 25 Little End Road, Eaton Socon, St. Neots, Cambridgeshire, PE19 8JH - United Kingdom  
Tel +44 (0)1480 475297 - Fax +44(0)1480 215378 - Email: [info@altrad-dessa.com](mailto:info@altrad-dessa.com)  
[www.altrad-dessa.com](http://www.altrad-dessa.com)